

Roamer





Enjoying the Journey.....



On a Mission

At Open Range RV, we are on a mission to...

Fulfill the trailer needs of our dealer base and retail customers, and in doing so, exceed their expectations for service, quality and value.

Earn our dealers', retail customers' and employees' long-term loyalty by delivering more than we promise, in a fair and honest business manner.

Motivate our employees to provide exceptional service and quality to our retail customers and dealers.

Compensate our employees fairly and provide opportunity for personal growth within our company.

Although it is our goal to provide a product that exceeds our customer needs and level of quality, we do not strive to be the biggest or the most profitable. In the end, we believe satisfied customers, dealers and employees will bring growth and long term profitability for all.

For almost 30 years, I have had the great fortune to work in the amazing industry of RV manufacturing. This industry runs through my blood and is the passion of my life. This has been a dream come true for me and my family. I would like to thank everyone who believed in us as an RV Manufacturer. At Open Range our motto is ENJOY THE JOURNEY!

It has been an amazing JOURNEY so far! Come join us on this great JOURNEY, we don't want you to miss another moment of it.

Enjoy the Journey!



Randy Graber, President
Open Range RV Company



RF316RLS Entertainment Center and Dinette



Deep Under Bed Storage



RF316RLS Kitchen



Full Extension Drawer Guides

Out Side Kitchen Center (Travel Trailers Only)



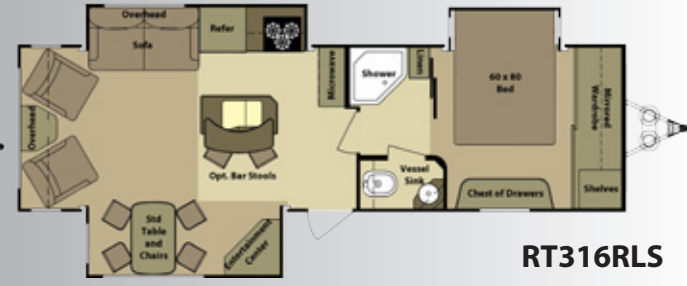
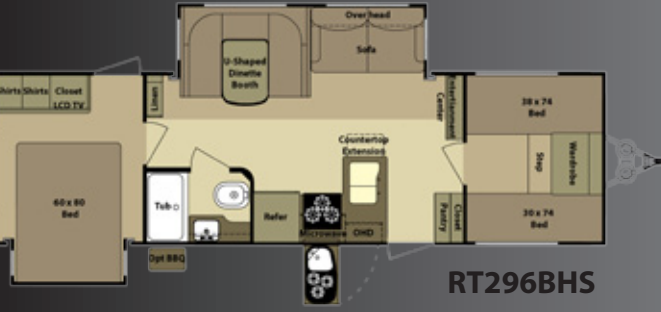
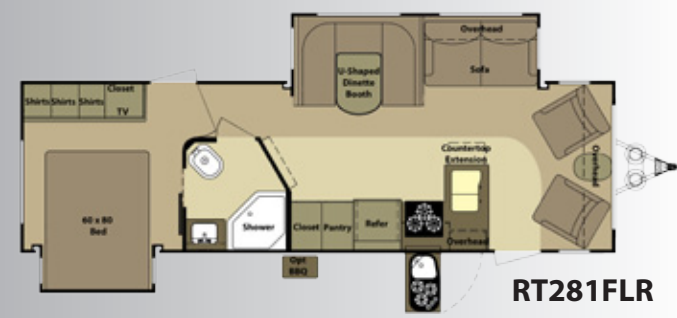
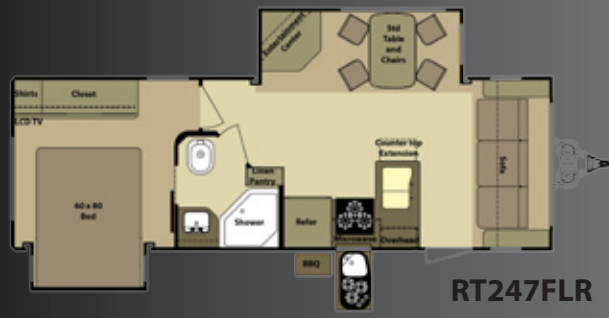

	GVWR	UVW	Hitch Wt.	Axle Wt.	Gross NCC	Ext. Length	Ext. Height	Ext. Width	Water Heater (Gas/Elec)	Fresh Water (Gal)	Waste (Gal)	Grey Water (Gal)	Furance BTU's	LP Gas (Lbs)	Tire Size
RT247FLR	9650	6545	850	5695	3105	29'	133"	100"	6 Gal	50	30	60	30,000	60	15"
RT266RLS	9485	6415	685	5730	3070	30'9"	133"	100"	6 Gal	50	30	60	30,000	60	15"
RT281FLR	9710	6780	910	5870	2930	32'	133"	100"	6 Gal	50	30	60	30,000	60	15"
RT296BHS	9530	7115	730	6385	2415	33'	133"	100"	6 Gal	50	30	60	30,000	60	15"
RT303BHS	9545	7115	745	6370	2430	33'	133"	100"	6 Gal	50	30	60	30,000	60	15"
RT316RLS	10090	7745	1290	6455	2345	33'8"	133"	100"	6 Gal	50	30	60	30,000	60	15"
RT331BHS	11150	7415	750	6665	3735	36'8"	133"	100"	6 Gal	50	30	60	30,000	60	15"



RF270RLS



RF280RLS



RF287RLS



RF298BWS



RF316RLS



RF392BHS

	GVWR	UWV	Hitch Wt.	Axle Wt.	Gross NCC	Ext. Length	Ext. Height	Ext. Width	Water Heater (Gas/Elec)	Fresh Water (Gal)	Waste (Gal)	Grey Water (Gal)	Furance BTU's	LP Gas (Lbs)	Tire Size
RF270RLS	9990	7390	1215	6175	2600	28'6"	153"	100"	6 Gal	81	41	82	35,000	80	15"/16" Opt
RF280RLS	10175	7870	1375	6495	2305	28'	153"	100"	6 Gal	81	41	98	35,000	80	15"/16" Opt
RF287RLS	10175	7770	1375	6395	2405	29'6"	153"	100"	6 Gal	81	41	82	35,000	80	15"/16" Opt
RF298BWS	10440	8045	1665	6380	2395	30'3"	153"	100"	6 Gal	81	41	82	35,000	80	15"/16" Opt
RF316RLS	10935	8565	2135	6430	2370	30'10"	153"	100"	6 Gal	81	82	82	35,000	80	15"/16" Opt
RF392BHS	13755	10405	1755	8650	2597	38'9"	153"	100"	6 Gal	81	82	82	40,000	80	15"/16" Opt

Features On your Roamer

Travel Trailers



Convenience Center

Bright LED
Tail Light

Fifth Wheels



Convenience
Center

4-Point Leveling and
Stabilizing System

Slide-out LP
Bottles
80 Lbs Capacity

Fifth Wheels & Travel Trailers

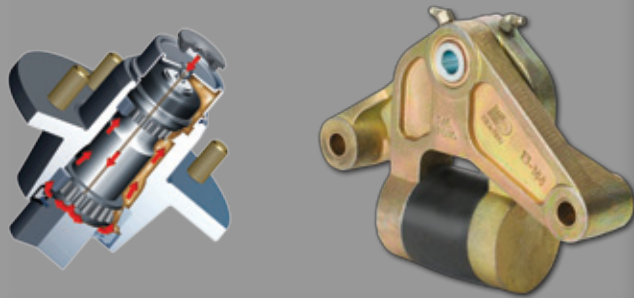

E-Z Lube™ Axles
Repack Your Bearing
Without Disassembly

Trailer
E-Z FLEX
Suspension



Compression
Latches



Extended Water
Spout



Large Stainless
Steel Entry Door
Grab Handle



"Smart Cord"
With LED
Power Confirmation



Full View
Vented Entrance
Door



Roamer

- 2 Year Warranty
- 100" Exterior Width
- 42" Deep Main Slide
- 15,000 BTU A/C Ducted with Residential Return Air and Heat Pump (Fifth Wheels)
- 13,500 BTU A/C Ducted (Travel Trailers)
- Nitrogen Filled Radial Tires
- Gel Coated Fiberglass Walls
- LED Taillights
- 4 Point Compression NORCO Slide Out System
- Less Weight / More Room
- Removable Exterior Ladder (Fifth Wheels)
- R-38 Ceiling & R-38 Flooring Insulation*
- Full View Vented Entrance Door
- Slam Latch Baggage Doors
- Pull Out Waste Basket
- Pull Out Pantry
- Concealed Hinges
- Residential Size Bed
- Deeper Dresser Drawers

OPEN RANGE

www.OpenRangeRV.com

* = Calculated

Interior Features	Roamer T/T	Roamer F/W
Interior Width (Without Slides)	96"	96"
Slide Out Height	5'7"	6'5"
Deep Main Slide	42"	42"
Residential Carpeting and Rebound Padding	Std	Std
Beauflor Resilliant Flooring	Std	Std
High Output Range with Oven	Std	Std
Knotty Alderwood Cabinet Doors	Std	Std
Full Extension Drawer Guides with Steel Ball Bearings	Std	Std
Fluorescent Light with Night Light over Galley Sink	Std	Std
Pull Out Trash Can	Std	Std
High Pressure Laminate Counter Tops & Edging	Std	Std
Sink Covers	Std	Std
Residential Size Sink Strainers (3")	Std	Std
Extra Large Pots and Pans Drawer in Galley	N/A	Std
Sky Light Over Shower or Tub	Std	Std
Swivel Rocking Chairs (On Select Models)	Std	Std
Porcelain Toilet with Foot Flush and "Water Saver"	Std	Std
Cable Hook Up	Std	Std
Direct Satellite Connections to Each TV Jack	Pkg	Pkg
Insulated Slide Floors	Pkg	Pkg
LCD TV in Living Room	Pkg	Pkg

Interior Features	Roamer T/T	Roamer F/W
Residential Size Innerspring Mattress	Std	Std
Deluxe Bedsread and Pillow Shams	Std	Std
High Output Microwave Oven	Std	Std
Full System Electronic Monitor Panel	Std	Std
Hide-a-Bed	Pkg	Pkg
Galley Sink Front Tip Out Trays	Pkg	Pkg
Entertainment Center DVD/CD/AM/FM/Stereo	Pkg	Pkg
Pull Out Pantry	Pkg	Pkg
Double Door Refrigerator with "Custom Temperature Control"	Pkg	Pkg
Forced Air Auto Ignition Furnace	Pkg	Pkg
19" LCD TV in Bedroom	Opt	Opt
Outside Dual Speakers by Door Side (N/A RT316RLS)	Pkg	Pkg
Exterior Features		
Utility Center (Tank Flush, Dump Valve, Spray Hose, TV, Water, and Electric)	Std	Std
Dexter "EZ LUBE" Axles	Std	Std
Dexter "EZ Flex" Rocker Arm Suspension	Std	Std
Front Electric Jacks	Opt	Std
"Heavy Duty" Scissor Stabilizer Jacks	Std	N/A
Exterior Security Lights	Std	Std
4-Point Leveling and Stabilization System	N/A	Std
Remote for 4-Point Leveling	N/A	Opt

Exterior Features	Roamer T/T	Roamer F/W
Optional Aluminum Wheels & Tire	15"	16"
"Double" Extension Gutter Rails	Std	Std
Stainless Steel Assist Grab Handle	Std	Std
Amp Service	30 A	50 A
Rear Removable Exterior Ladder	Opt	Opt
Water Heater Bypass Kit	Std	Std
Winterizing Valve Control System	Std	Std
Heavy Tint Safety Glass	Std	Std
Gel Coated Fiberglass Walls	Std	Std
Slam Latch Baggage Doors	Std	Std
Mounted Spare Tire	Std	Std
Gas/Electric Quick Recovery Water Heater	6 Gal	6 Gal
Winegard® Digital TV Antenna with Power Booster	Pkg	Pkg
Carefree Power Awning	Pkg	Pkg
Heated and Enclosed Underbelly	Pkg	Pkg
Double Insulated Baggage Door	Pkg	Pkg
R38 Roof and R38 Floor Insulation	Std	Std
Outside Cook Center	Std	N/A
Larger Triple 9" Entry Door Steps	Std	Std
BBQ Grill	Opt	Opt
Power Tongue Jack	Opt	N/A
Radial Tires	Std	Std
Dual Slide Trays With Up To 80Lbs of LP	N/A	Std
60 Lbs LP Capacity	Std	N/A

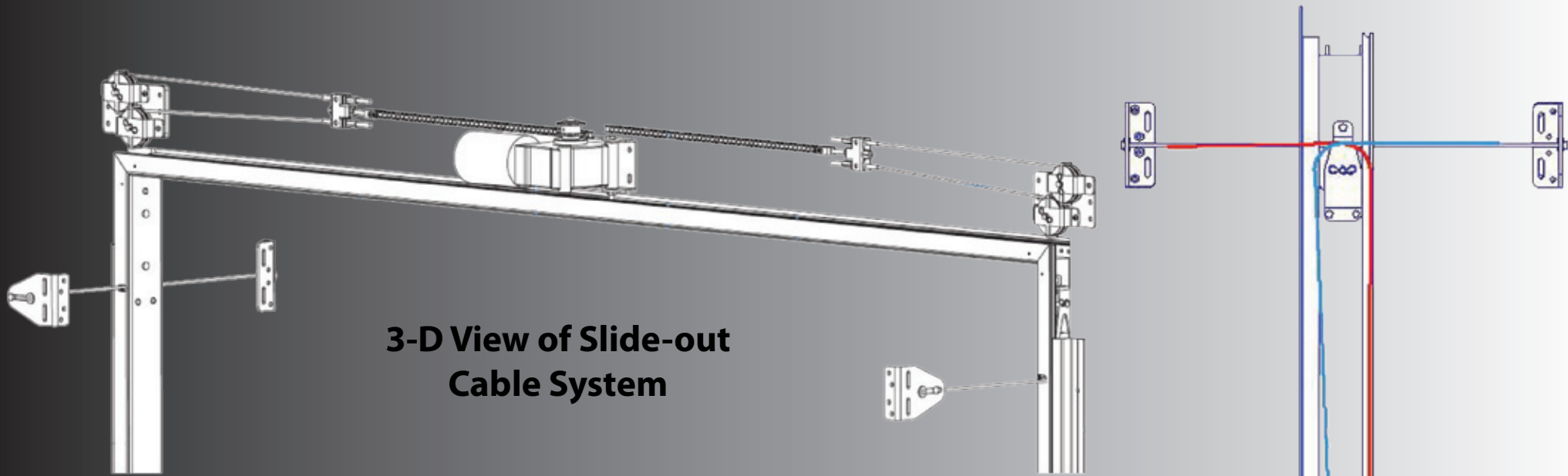

3-D View of Slide-out Cable System

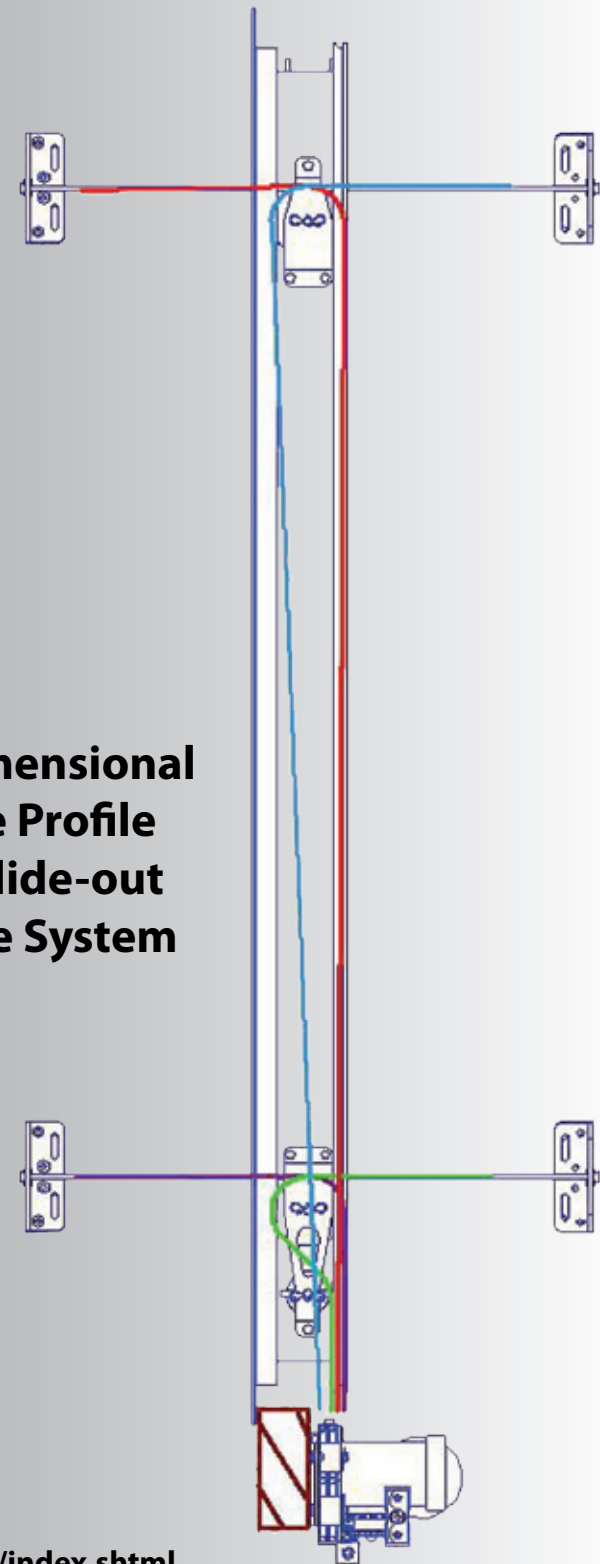

1- Dimensional Side Profile Of Slide-out Cable System

10 Reasons Why... Accu-Slide

- 1. Above floor design means more storage area for your RV**
- 2. Lightweight design promotes fuel savings**
- 3. High strength stainless steel aircraft cable is used for control**
- 4. Cable control at all 4 room corners helps stop leaks**
- 5. Working components are in your RV, safe from the elements**
- 6. Locking motor secures room in or out to help stop leaks**
- 7. Above floor design minimizes maintenance requirements**
- 8. A clean system - no leaky hydraulic lines or greasy drives**
- 9. Smooth, quiet room movement - no jumping or jerking**
- 10. It's built in the U.S.A. and backed by BAL since 1972**

For more information please visit: <http://norcoind.com/bal/products/oem/accuslide/index.shtml>

Sheridan



Lifelong



Sedonna





DSI

**RVDA DEALER
SATISFACTION INDEX**

Open Range RV Company is extremely proud and honored to have received the "Quality Circle Award" two years running now from the RVDA. It gives us great satisfaction that our dealers have distinguished our company and product from the competition. Open Range RV vows to continue the commitment to a quality product, company, and employee base.

We at Open Range RV hope you choose to join our ever growing RV family and that you remember to...

Enjoy The Journey!



Open Range RV Company 3195 N. St. Rd. 5 Shipshewana, IN 46565

Phone: (260) 768-7771 - www.OpenRangeRV.com

Due to Continual research and advances , manufacturer reserves the right to change specifications, design, price, and equipment without notice, and assumes no responsibility for any error in the literature. Some items shown are not included as standard or optinal equipment

©2010 Open Range RV Company, Shipshewana, Indiana

Your Open Range Dealer: